

Fittings, Tubing & Nipples

Medium Pressure

Pressures to 20,000 psi (1379 bar)

Since 1945 Autoclave Engineers has designed and built premium quality valves, fittings and tubing. This commitment to engineering and manufacturing excellence has earned Autoclave a reputation for reliable, efficient product performance. Autoclave Engineers has long been established as the world leader in high pressure fluid handling components for the chemical/petrochemical, research, and oil and gas industries.



Medium Pressure Fittings, Tubing and Nipples Features:

- Coned-and-Threaded Connection.
- Available sizes are 1/4", 3/8", 9/16", 3/4", 1" and 1-1/2".
- Fittings and tubing manufactured from cold worked 316 stainless steel.
- Operating Temperatures from -423°F (-252°C) to 1200°F (649°C).
- Anti-vibration connection components available.
- All items available in special material.

The medium pressure series uses Autoclave's medium pressure connection. This coned-and-threaded connection features orifice sizes to match the high flow characteristics of this series.

**Autoclave
Engineers** 

Fluid Components
Division of Snap-tite, Inc.
www.autoclave.com

Fittings, Tubing & Nipples - Medium Pressure

Medium Pressure Fittings

Pressures to 20,000 psi (1379 bar)

Autoclave Engineers medium pressure fittings, Series SF, are designed for use with Series 20SM medium pressure valves and Autoclave medium pressure tubing. They incorporate medium pressure coned-and-threaded connections with orifices sized to match the high-flow Series 20SC valves.

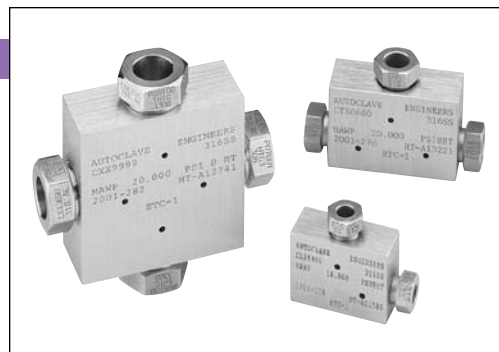

Connection Components

All Autoclave valves and fittings are supplied complete with appropriate glands and collars. To order these components separately, use order numbers listed. When using plug, collar is not required.

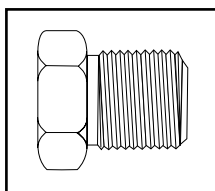

Gland
CGLX ()

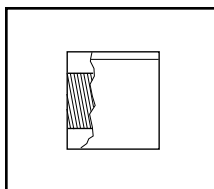

Collar
CCLX ()

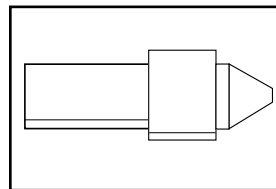

Plug
CPX ()

Add tube size ()
1/4" - 40
3/8" - 60
9/16" - 90
3/4" - 120
1" - 160
1-1/2" - 240

Example:
1/4" Gland - CGLX 40

To ensure proper fit use Autoclave Engineers tubing.

Note: Special material glands may be supplied with four flats in place of standard hex.

Catalog Number	Connection Type	Outside Diameter Tube	Pressure Rating psi (bar)*	Minimum Opening	Dimensions - inches (mm)							Block Thickness	Fitting Pattern
					A	B	C	D Typical	E	F	G Thickness		

Elbow

CLX4400	SF250CX	1/4 (6.35)	20,000 (1378.93)	0.125 (3.18)	1.12 (28.45)	1.50 (38.10)	0.38 (9.65)	0.50 (12.70)	0.75 (19.05)	0.75 (19.05)		0.62 (15.75)	See Figure 1
CLX6600	SF375CX	3/8 (9.53)	20,000 (1378.93)	0.219 (5.56)	1.38 (35.05)	2.00 (50.80)	0.44 (11.10)	0.62 (15.75)	1.00 (25.40)	1.00 (25.40)		0.75 (19.05)	
CLX9900	SF562CX	9/16 (14.29)	20,000 (1378.93)	0.359 (9.12)	1.75 (44.45)	2.50 (63.50)	0.53 (13.46)	0.94 (23.88)	1.25 (31.75)	1.25 (31.75)		1.00 (25.40)	
CLX12	SF750CX	3/4 (19.05)	20,000 (1378.93)	0.516 (13.11)	2.25 (57.15)	3.00 (76.20)	0.62 (15.75)	1.19 (30.23)	1.50 (38.10)	1.50 (38.10)		1.38 (34.93)	
CLX16	SF1000CX	1 (25.40)	20,000 (1378.93)	0.688 (17.48)	3.00 (76.20)	4.12 (104.65)	0.72 (18.29)	1.38 (35.05)	2.06 (52.32)	2.06 (52.32)		1.75 (44.45)	
CLX24	SF1500CX	1-1/2 (38.10)	15,000 (1034.20)	0.94 (23.80)	4.00 (101.60)	5.75 (146.05)	1.12 (28.45)	1.88 (47.63)	2.88 (73.03)	2.88 (73.03)		2.25 (57.15)	

*Maximum pressure rating is based on the lowest rating of any component.

Actual working pressure may be determined by tubing pressure rating, if lower.

All dimensions for reference only and subject to change.

For prompt service, Autoclave stocks select products.

Consult your local representative.

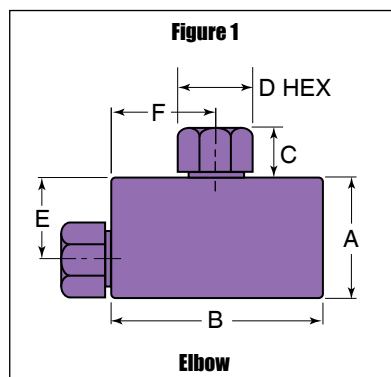

For mounting hole option add suffix PM to catalog number. Consult factory for mounting hole dimensions.

Catalog Number	Connection Type	Outside Diameter Tube	Pressure Rating psi (bar)*	Minimum Opening	Dimensions - inches (mm)							Block Thickness	Fitting Pattern
					A	B	C	D Typical	E	F	G Thickness		

Tee

CTX4440	SF250CX	1/4 (6.35)	20,000 (1378.93)	0.125 (3.18)	1.12 (28.45)	1.50 (38.10)	0.38 (9.65)	0.50 (12.70)	0.75 (19.05)	0.75 (19.05)		0.62 (15.75)	See Figure 2
CTX6660	SF375CX	3/8 (9.53)	20,000 (1378.93)	0.219 (5.56)	1.38 (35.05)	2.00 (50.80)	0.44 (11.10)	0.62 (15.75)	1.00 (25.40)	1.00 (25.40)		0.75 (19.05)	
CTX9990	SF562CX	9/16 (14.29)	20,000 (1378.93)	0.359 (9.12)	1.75 (44.45)	2.50 (63.50)	0.53 (13.46)	0.94 (23.88)	1.25 (31.75)	1.25 (31.75)		1.00 (25.40)	
CTX12	SF750CX	3/4 (19.05)	20,000 (1378.93)	0.516 (13.11)	2.25 (57.15)	3.00 (76.20)	0.62 (15.75)	1.19 (30.23)	1.50 (38.10)	1.50 (38.10)		1.38 (34.93)	
CTX16	SF1000CX	1 (25.40)	20,000 (1378.93)	0.688 (17.48)	3.00 (76.20)	4.12 (104.65)	0.72 (18.29)	1.38 (35.05)	2.06 (52.32)	2.06 (52.32)		1.75 (44.45)	
CTX24	SF1500CX	1-1/2 (38.10)	15,000 (1034.20)	0.94 (23.80)	4.00 (101.60)	5.75 (146.05)	1.12 (28.45)	1.88 (47.63)	2.88 (73.03)	2.88 (73.03)		2.25 (57.15)	

Cross

CXX4444	SF250CX	1/4 (6.35)	20,000 (1378.93)	0.125 (3.18)	1.50 (38.10)	1.50 (38.10)	0.38 (9.65)	0.50 (12.70)	0.75 (19.05)	0.75 (19.05)		0.62 (15.75)	See Figure 3
CXX6666	SF375CX	3/8 (9.53)	20,000 (1378.93)	0.219 (5.56)	2.00 (50.80)	2.00 (50.80)	0.44 (11.10)	0.62 (15.75)	1.00 (25.40)	1.00 (25.40)		0.75 (19.05)	
CXX9999	SF562CX	9/16 (14.29)	20,000 (1378.93)	0.359 (9.12)	2.50 (63.50)	2.50 (63.50)	0.53 (13.46)	0.94 (23.88)	1.25 (31.75)	1.25 (31.75)		1.00 (25.40)	
CXX12	SF750CX	3/4 (19.05)	20,000 (1378.93)	0.516 (13.11)	3.00 (76.20)	3.00 (76.20)	0.62 (15.75)	1.19 (30.23)	1.50 (38.10)	1.50 (38.10)		1.38 (34.93)	
CXX16	SF1000CX	1 (25.40)	20,000 (1378.93)	0.688 (17.48)	4.12 (104.65)	4.12 (104.65)	0.72 (18.29)	1.38 (35.05)	2.06 (52.32)	2.06 (52.32)		1.75 (44.45)	
CXX24	SF1500CX	1-1/2 (38.10)	15,000 (1034.20)	0.94 (23.80)	5.75 (146.05)	5.75 (146.05)	1.12 (28.45)	1.88 (47.63)	2.88 (73.03)	2.88 (73.03)		2.25 (57.15)	

*Maximum pressure rating is based on the lowest rating of any component. Actual working pressure may be determined by tubing pressure rating, if lower.

All dimensions for reference only and subject to change. For prompt service, Autoclave stocks select products. Consult your local representative.

For mounting hole option add suffix PM to catalog number. Consult factory for mounting hole dimensions.

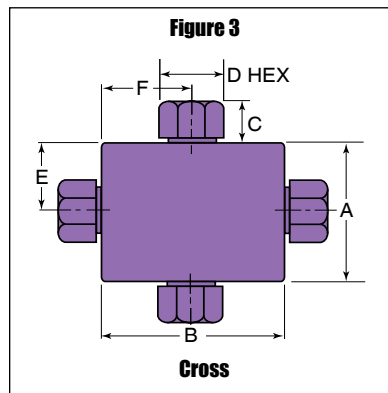
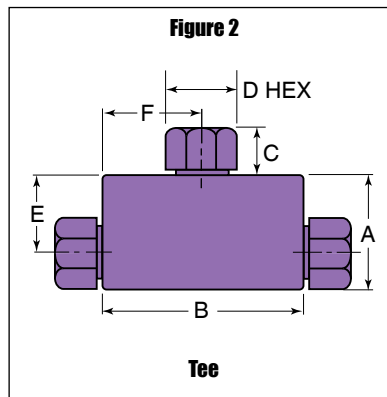

Catalog Number	Connection Type	Outside Diameter Tube	Pressure Rating psi (bar)*	Minimum Opening	Dimensions - inches (mm)							Block Thickness	Fitting Pattern
					A	B	C	D Typical	E	F	G Thickness		

Straight Coupling / Union Coupling

20FX4466 20UFX4466	SF250CX	1/4 (6.35)	20,000 (1378.93)	0.125 (3.18)	0.62 (15.75)	1.62 (41.15)	0.38 (9.65)	0.50 (12.70)					Straight Union	See Figure 4
20FX6666 20UFX6666	SF375CX	3/8 (9.53)	20,000 (1378.93)	0.219 (5.56)	0.75 (19.05)	1.75 (44.45)	0.44 (11.10)	0.62 (15.75)					Straight Union	
20FX9966 20UFX9966	SF562CX	9/16 (14.29)	20,000 (1378.93)	0.359 (9.12)	1.00 (25.40)	2.12 (53.85)	0.53 (13.46)	0.94 (23.88)					Straight Union	
20FX12 20UFX12	SF750CX	3/4 (19.05)	20,000 (1378.93)	0.516 (13.11)	1.38 (35.05)	2.50 (63.50)	0.62 (15.75)	1.19 (30.23)					Straight Union	
20FX16 20UFX16	SF1000CX	1 (25.40)	20,000 (1378.93)	0.688 (17.48)	1.75 (44.45)	3.50 (88.90)	0.72 (18.29)	1.38 (35.05)					Straight Union	
15FX24 15UFX24	SF1500CX	1-1/2 (38.10)	15,000 (1034.20)	0.94 (23.80)	1.88 (47.63)	5.00 (127.00)	1.12 (28.45)	1.88 (47.63)					Straight Union	

Bulkhead Coupling

20BFX4466	SF250CX	1/4 (6.35)	20,000 (1378.93)	0.125 (3.18)	0.81 (20.57)	1.88 (47.75)	0.38 (9.65)	0.50 (12.70)	0.53 (13.46)	1.00 (25.40)	0.38 (9.65)		See Figure 5
20BFX6666	SF375CX	3/8 (9.53)	20,000 (1378.93)	0.219 (5.56)	0.94 (23.88)	2.00 (50.80)	0.44 (11.10)	0.62 (15.75)	0.62 (15.75)	1.00 (25.40)	0.38 (9.65)		
20BFX9966	SF562CX	9/16 (14.29)	20,000 (1378.93)	0.359 (9.12)	1.12 (28.45)	2.38 (60.45)	0.53 (13.46)	0.94 (23.88)	0.78 (19.81)	1.38 (35.05)	0.38 (9.65)		
20BFX12	SF750CX	3/4 (19.05)	20,000 (1378.93)	0.516 (13.11)	1.69 (42.93)	2.62 (66.55)	0.62 (15.75)	1.19 (30.23)	0.91 (23.11)	1.88 (47.75)	0.38 (9.65)		
20BFX16	SF1000CX	1 (25.40)	20,000 (1378.93)	0.688 (17.48)	1.94 (49.28)	3.50 (88.90)	0.72 (18.29)	1.38 (35.05)	1.50 (38.10)	1.88+ (47.75)	0.38 (9.65)		
15BFX24	SF1500CX	1-1/2 (38.10)	15,000 (1034.20)	0.94 (23.80)	2.31 (58.72)	5.00 (127.00)	1.12 (28.45)	1.88 (47.63)	2.00 (50.80)	1.88 (47.63)	0.38 (9.65)		

*Maximum pressure rating is based on the lowest rating of any component.
Actual working pressure may be determined by tubing pressure rating, if lower.

+ distance across flats

All dimensions for reference only and subject to change.
For prompt service, Autoclave stocks select products.
Consult your local representative.

Union Couplings are designed with a removable seat insert allowing disassembly and tubing removal without the necessity of loosening other items in a line.

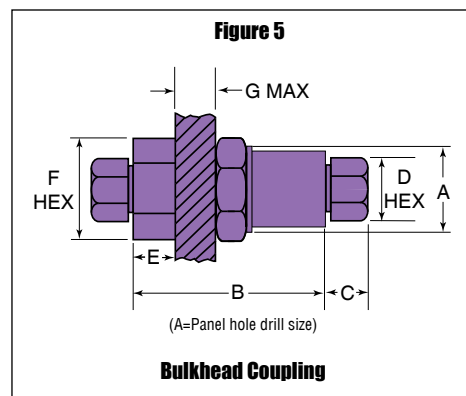
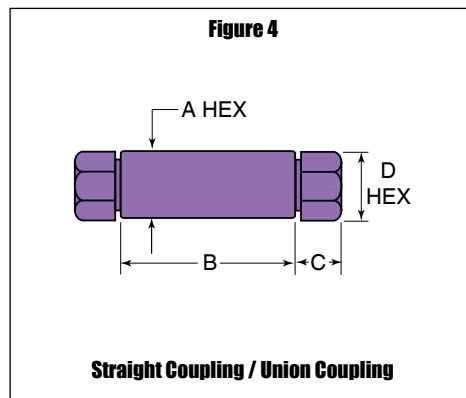

Medium Pressure Tubing

Pressures to 20,000 psi (1379 bar)

Autoclave Engineers offers a complete selection of austenetic, cold drawn stainless steel tubing designed to match the performance standards of Autoclave valves and fittings. Autoclave medium pressure tubing is manufactured specifically for high pressure applications requiring both strength and corrosion resistance. The tubing is furnished in random lengths between 20 feet (6 meters) and 27 feet (8.2 meters). The average is 24 feet (7.3 meters). Medium Pressure Tubing is available in five sizes and a variety of materials.



Inspection and Testing

Autoclave Engineer's medium pressure tubing is inspected to assure freedom from seams, laps, fissures or other flaws, as well as carburization or intergranular carbide precipitation. The outside and inside diameters of the tubing are subject to special inspection and are controlled within close tolerances to assure proper fit. Sample pieces of tube for each lot are tested to confirm mechanical properties. Hydrostatic testing is also performed on a statistical basis and is conducted at the working pressure of the tube. Autoclave will perform 100% hydrostatic testing at additional cost if desired.

Special Materials

In addition to the type 316 and 304 stainless steel tubing listed in this section, Autoclave has limited stock of hard-to-obtain shorter lengths of the following tubing materials:

*Monel 400**, *Inconel 600**, *Titanium Grade 2**, *Nickel 200**, *Hastelloy C276** - (* Trademark names)

Please consult factory for stock availability.

Tubing Tolerance

Nominal Tubing Size
inches (mm)

Tolerance/Outside Diameter
inches (mm)

1/4 (6.35)	.248/.243 (6.30/6.17)
3/8 (9.53)	.370/.365 (9.40/9.27)
9/16 (14.27)	.557/.552 (14.15/14.02)
3/4 (19.05)	.745/.740 (18.92/18.80)
1 (25.40)	.995/.990 (25.27/25.14)
1-1/2 (38.10)	1.495/1.490 (37.98/37.85)

Catalog Number	Tube Material	Fits Connection Type	Tube Size Inches (mm)			Flow Area in. ² (mm ²)	Working Pressure psi (bar)*				
			Outside Diameter	Inside Diameter	Wall Thickness		-325 to 100°F -198 to 37.8°C	200°F 93°C	400°F 204°C	600°F 316°C	800°F 427°C
MS15-092	316SS	SF250CX	1/4 (6.35)	0.109 (2.77)	0.070 (1.78)	0.009 (5.81)	20,000 (1378.93)	20,000 (1378.93)	19,250 (1327.22)	18,050 (1244.48)	16,800 (1158.30)
MS15-192	304SS						20,000 (1378.93)	18,950 (1306.54)	17,200 (1185.88)	17,000 (1172.09)	16,150 (1113.49)
MS15-093	316SS	SF375CX	3/8 (9.53)	0.203 (5.16)	0.086 (2.18)	0.032 (20.65)	20,000 (1378.93)	20,000 (1378.93)	19,250 (1327.22)	18,050 (1244.48)	16,800 (1158.30)
MS15-193	304SS						20,000 (1378.93)	20,000 (1378.93)	19,250 (1327.22)	18,050 (1244.48)	16,800 (1158.30)
MS15-085	316SS	SF562CX	9/16 (14.29)	0.312 (7.92)	0.125 (3.18)	0.076 (49.03)	20,000 (1378.93)	20,000 (1378.93)	19,250 (1327.22)	18,050 (1244.48)	16,800 (1158.30)
MS15-187	304SS						20,000 (1378.93)	20,000 (1378.93)	19,250 (1327.22)	18,050 (1244.48)	16,800 (1158.30)
MS15-097	316SS	SF562CX	9/16 (14.29)	0.359 (9.12)	0.101 (2.57)	0.101 (65.16)	15,000 (1034.16)	15,000 (1034.16)	14,400 (992.83)	13,650 (941.12)	12,670 (873.55)
MS15-194	304SS						15,000 (1034.16)	14,170 (976.97)	12,900 (889.41)	12,750 (879.07)	12,670 (873.55)
MS15-095	316SS	SF750CX	3/4 (19.05)	0.438 (11.13)	0.156 (3.96)	0.151 (97.42)	20,000 (1378.93)	20,000 (1378.93)	19,250 (1327.22)	18,050 (1244.48)	16,800 (1158.30)
MS15-098	316SS			0.516 (13.11)	0.117 (2.97)	0.209 (134.84)	15,000 (1034.16)	15,000 (1034.16)	14,400 (992.83)	13,650 (941.12)	12,670 (873.55)
MS15-096	316SS	SF1000CX	1 (25.40)	0.562 (14.27)	0.219 (5.56)	0.248 (160.00)	20,000 (1378.93)	20,000 (1378.93)	19,250 (1327.22)	18,050 (1244.48)	16,800 (1158.30)
MS15-099	316SS			0.688 (17.48)	0.156 (3.96)	0.371 (239.35)	15,000 (1034.16)	15,000 (1034.16)	14,400 (992.83)	13,650 (941.12)	12,670 (873.55)
13041	316SS	SF1500CX	1-1/2 (38.10)	0.937 (23.80)	0.281 (7.15)	0.589 (444.88)	15,000 (1034.16)	15,000 (1034.16)	14,430 (994.90)	13,530 (932.85)	12,600 (868.73)

Note: Caution should be exercised in proper selection of Medium Pressure Tubing based on actual operating conditions. Two series available: 15,000 psi (1034 bar) and 20,000 psi (1379 bar).

*Maximum pressure rating is based on the lowest rating of any component.

Actual working pressure may be determined by tubing pressure rating, if lower.

All dimensions for reference only and subject to change.

For prompt service, Autoclave stocks select products. Consult your local representative.

Medium Pressure Coned-and-Threaded Nipples

Pressures to 20,000 psi (1379 bar)

For rapid system make-up, Autoclave Engineers supplies pre-cut, coned-and-threaded nipples in various sizes and lengths for Autoclave medium pressure valves and fittings.

Special lengths

In addition to the standard lengths listed in the table below, nipples are available in any custom length. Consult factory.

Materials**

Catalog numbers in table refer to Type 316 Stainless steel. Optional materials available. Consult factory.



Catalog Number							Fits Connection Type	Tube Size inches (mm)		Working Pressure at 100°F psi (bar)*
Nipple Length In (mm)								O.D.	I.D.	
2.75" (69.85)	3.00" (76.20)	4.00" (101.60)	6.00" (152.40)	8.00" (203.20)	10.00" (254.00)	12.00" (304.80)				
CNX4402-316	CNX4403-316	CNX4404-316	CNX4406-316	CNX4408-316	CNX44010-316	CNX44012-316	SF250CX	1/4 (6.35)	0.109 (2.77)	20,000 (1378.93)
	CNX6603-316	CNX6604-316	CNX6606-316	CNX6608-316	CNX66010-316	CNX66012-316	SF375CX	3/8 (9.53)	0.203 (5.16)	20,000 (1378.93)
		CNX9904-316	CNX9906-316	CNX9908-316	CNX99010-316	CNX99012-316	SF562CX	9/16 (14.29)	0.312 (7.92)	20,000 (1378.93)
		CNLX9904-316	CNLX9906-316	CNLX9908-316	CNLX99010-316	CNLX99012-316	SF562CX	9/16 (14.29)	0.359 (9.12)	15,000 (1034.16)
			CNX1206-316	CNX1208-316	CNX12010-316	CNX12012-316	SF750CX	3/4 (19.05)	0.438 (11.13)	20,000 (1378.93)
			CNLX1206-316	CNLX1208-316	CNLX12010-316	CNLX12012-316	SF750CX	3/4 (19.05)	0.516 (13.11)	15,000 (1034.16)
			CNX1606-316	CNX1608-316	CNX16010-316	CNX16012-316	SF1000CX	1 (25.40)	0.562 (14.27)	20,000 (1378.93)
			CNLX1606-316	CNLX1608-316	CNLX16010-316	CNLX16012-316	SF1000CX	1 (25.40)	0.688 (17.48)	15,000 (1034.16)
			CNLX2406-316	CNLX2408-316	CNLX2410-316	CNLX2412-316	SF1500CX	1-1/2 (38.10)	0.937 (23.79)	15,000 (1034.16)

Note: Caution should be exercised when selecting medium pressure nipples since two series are available: 15,000 psi (1034.16 bar) and 20,000 psi (1379 bar)

See medium pressure tubing section for pressures at various temperatures.

*Maximum pressure rating is based on the lowest rating of any component. Actual working pressure may be determined by tubing pressure rating, if lower.
**Type 304 Stainless Steel nipples available.

All dimensions for reference only and subject to change.

Medium Pressure Check Valves

Pressures to 20,000 (1379 bar)

O-Ring Check Valves

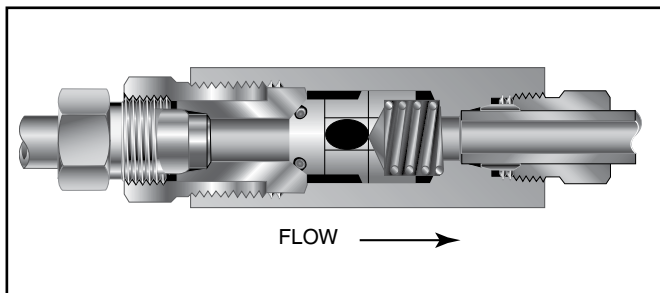

Minimum operating temperature for standard o-ring check valves 0°F (17.8°C).

For low temperature option to -423°F (-252°C) add suffix LTTO (Low temperature spring & Teflon o-ring).

Provides unidirectional flow and tight shut-off for liquids and gas with high reliability. When differential drops below cracking pressure*, valve shuts off. **(Not for use as relief valve.)**

Materials: 316 Stainless Steel: body, cover, poppet, cover gland. 300 Series Stainless Steel: spring
Standard O-ring: Viton, for operation to 400° F (204°C).
Buna-N or Teflon available for 250°F (121°C) or 400°F (204°C) respectively; specify when ordering.

***Cracking Pressure:** 20 psi (1.38 bar) ±30%. Springs for higher cracking pressures (up to 100 psi (6.89 bar)) available on special order for O-ring style check valves only.

Ball Check Valves

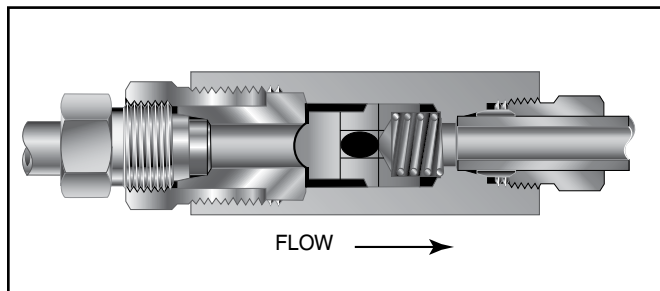

Minimum operating temperature for standard ball check valves -110° (-79°C).

For low temperature option to -423°F (-252°C) add suffix LT (Low temperature spring).

Prevents reverse flow where **leak-tight shut-off is not mandatory**. When differential drops below cracking pressure, valve closes. With all-metal components, valve can be used up to 1200°F (649°C). See Technical Information section for connection temperature limitations. (Not for use as a relief valve.)

The ball and poppet are an integral design to assure positive, in-line seating without “chatter”. Poppet is designed essentially for axial flow with minimum pressure drop.

Materials: 316 Stainless Steel: body, cover, ball, poppet, cover gland. 300 Series Stainless Steel: ball, spring.

Ball Type Excess Flow Valves

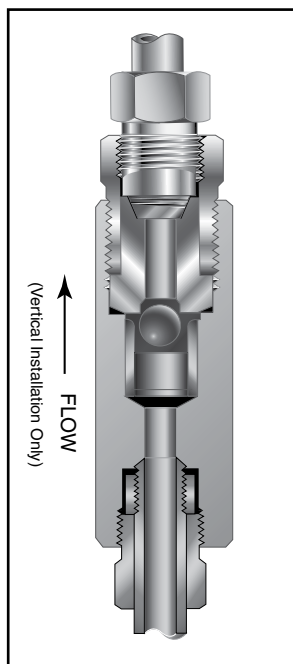

Protects pressure gauges and pressure instrumentation from surges in flow or sudden venting in the event of line failure.

Materials: 316 Stainless Steel: body, cover, sleeve, cover gland. 300 Series Stainless Steel: ball.

Vertical Installation: Since this type of check valve employs a non-spring loaded ball, valve **MUST** be installed in VERTICAL position with arrow on valve body pointing UP. (cover gland up).

Resetting Valve: Equalize the pressure across the ball. The ball will drop and reset automatically.

CAUTION: While testing has shown O-Rings to provide satisfactory service life, both cyclic and shelf life may vary widely with differing service conditions, properties of reactants, pressure and temperature cycling and age of the O-ring. **FREQUENT INSPECTIONS SHOULD BE MADE** to detect any deterioration, and O-rings replaced as required.

CAUTION: See Tubing section for proper selection of tubing.
NOTE: For optional material see Needle Valve Options section.

NOTE: Special material check valves may be supplied with four flats in place of standard hex.

Medium Pressure Check Valves

Catalog Number	Fits Connection Type	Pressure Rating psi (bar)*	Orifice inches (mm)	Rated C _v	Dimensions - inches (mm)					Fitting Pattern
					A	B	C	D Typical	Hex	

O-Ring Check Valves

CXO4400	SF250CX	20,000 (1378.93)	0.125 (3.18)	0.28	2.94 (74.68)	2.50 (63.50)	0.38 (9.65)	0.50 (12.70)	0.81 (20.57)	See Figure 1
CXO6600	SF375CX	20,000 (1378.93)	0.218 (5.54)	0.84	3.12 (79.25)	2.62 (66.55)	0.47 (11.94)	0.62 (15.75)	1.00 (25.40)	
CXO9900	SF562CX	20,000 (1378.93)	0.359 (9.12)	2.30	4.18 (106.17)	3.50 (88.90)	0.53 (13.46)	0.94 (23.88)	1.38 (35.05)	
CXO12	SF750CX	20,000 (1378.93)	0.516 (13.11)	4.70	5.50 (139.70)	4.75 (120.65)	0.62 (15.75)	1.19 (30.23)	1.75 (44.45)	
CXO16	SF1000CX	20,000 (1378.93)	0.688 (17.48)	7.40	6.63 (168.40)	5.75 (146.05)	0.72 (18.29)	1.38 (35.05)	2.12 (53.85)	

Ball Check Valves

CXB4400	SF250CX	20,000 (1378.93)	0.125 (3.18)	0.28	2.94 (74.68)	2.50 (63.50)	0.38 (9.65)	0.50 (12.70)	0.81 (20.57)	See Figure 1
CXB6600	SF375CX	20,000 (1378.93)	0.218 (5.54)	0.84	3.12 (79.25)	2.62 (66.55)	0.47 (11.94)	0.62 (15.75)	1.00 (25.40)	
CXB9900	SF562CX	20,000 (1378.93)	0.359 (9.12)	2.30	4.18 (106.17)	3.50 (88.90)	0.53 (13.46)	0.94 (23.88)	1.38 (35.05)	
CXB12	SF750CX	20,000 (1378.93)	0.516 (13.11)	4.70	5.50 (139.70)	4.75 (120.65)	0.62 (15.75)	1.19 (30.23)	1.75 (44.45)	
CXB16	SF1000CX	20,000 (1378.93)	0.688 (17.48)	7.40	6.63 (168.40)	5.75 (146.05)	0.72 (18.29)	1.38 (35.05)	2.12 (53.85)	
CXB24	SF1500CX	15,000 (1034.20)	0.94 (23.80)	14.00	9.01 (228.85)	7.25 (184.15)	1.12 (28.45)	1.88 (47.75)	+ 3.00 (76.20)	

Ball Type Excess Flow Valves

CXK4402	SF250CX	20,000 (1378.93)	0.125 (3.18)	0.37+	2.94 (74.68)	2.50 (63.50)	0.38 (9.65)	0.50 (12.70)	0.81 (20.57)	See Figure 1
CXK6602	SF375CX	20,000 (1378.93)	0.218 (5.54)	0.66+	3.12 (79.25)	2.62 (66.55)	0.47 (11.94)	0.62 (15.75)	1.00 (25.40)	
CXK9902	SF562CX	20,000 (1378.93)	0.359 (9.12)	.212+	4.18 (106.17)	3.50 (88.90)	0.53 (13.46)	0.94 (23.88)	1.38 (35.05)	
CXK1202	SF750CX	20,000 (1378.93)	0.516 (13.11)	.368+	5.12 (130.05)	4.38 (111.25)	0.62 (15.75)	1.19 (30.23)	1.75 (44.45)	
CXK1602	SF1000CX	20,000 (1378.93)	0.688 (17.48)	.864+	6.50 (165.10)	5.62 (142.75)	0.72 (18.29)	1.38 (35.05)	+ 1.88 (47.75)	

Note:

†-Check Flow - water, GPM

For flow rates using alternate fluids, consult Autoclave Engineers.

*Maximum pressure rating is based on the lowest rating of any component.

Actual working pressure may be determined by tubing pressure rating, if lower.

+ distance across flats

All dimensions for reference only and subject to change.

For prompt service, Autoclave stocks select products. Consult your local representative.

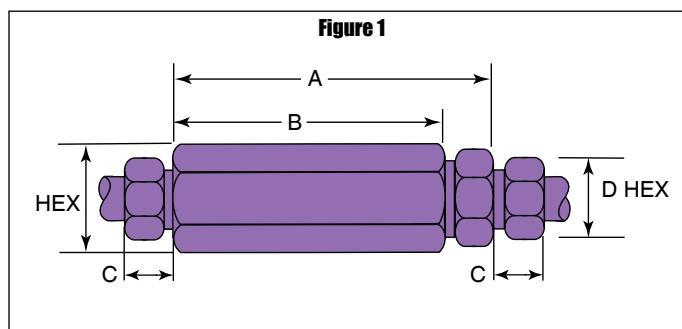

Medium Pressure Line Filters

Pressures to 20,000 psi (1379 bar)

Dual-Disc Line Filters

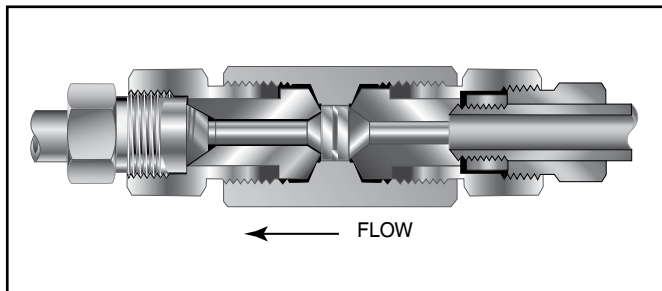

Autoclave Engineers Dual-Disc Line Filters are utilized in numerous industrial, chemical processing, aerospace, nuclear and other applications. With the dual-disc design, large contaminant particles are trapped by the upstream filter element before they can reach and clog the smaller micron-size downstream element. Filter elements can be easily replaced.

Materials: 316 Stainless Steel: body, cover, cover gland.
300 Series Stainless Steel: filter elements.

Filter Elements: Downstream/upstream micron size 35/65 is standard. 5/10 or 10/35 also available when specified. Other element combinations available on special order.

Cup-Type Line Filters

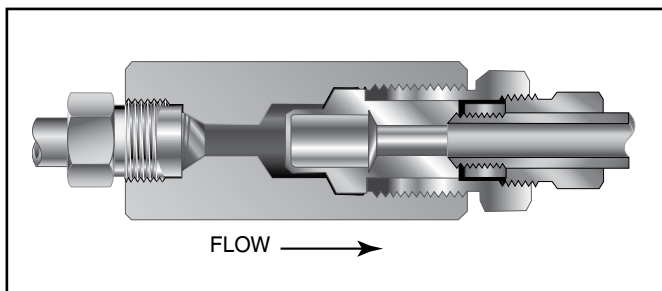

Autoclave Engineers High Flow Cup-Type Line Filters are recommended in high pressure systems requiring both high flow rates and maximum filter surface area. Widely used in the industrial and chemical processing fields, the cup design offers as much as six times the effective filter area as compared to disc-type units. In addition, the filter elements can be quickly and easily replaced.

Materials: 316 Stainless Steel: body, cover, cover gland.
300 Series Stainless Steel: filter element.

Filter Elements: Sintered cup elements available in choice of 5, 35 or 65 micron sizes. **Note:** Filter ratings are nominal.

NOTE 1: All filters furnished complete with connection components unless otherwise specified. All dimensions for reference only and subject to change.

For optional materials, see Needle Valve Options section

NOTE 2: Autoclave Engineers disc and cup type filters are designed to filter small amounts of process particles. It is recommended that all fluids are thoroughly cleaned prior to entering the higher pressure system.

NOTE 3: Special material filters may be supplied with four flats in place of standard hex.

NOTE 4: Pressure differential not to exceed 1,000 psi (69 bar) in a flowing condition.

Catalog Number	Pressure Rating psi (bar)*	Orifice inches (mm)	Micron Size**	Connection Size and Type	Effective Filter Element Area in. ² (mm ²)	Dimensions - inches (mm)				
						A	B	C	D Typical	Hex

Dual-Disc Line Filters

CLFX9900	20,000 (1378.93)	0.312 (7.92)	35/65	SF562CX	0.25 (161.29)	4.94 (125.48)	2.68 (68.07)	0.53 (13.46)	.94 (23.88)	1.38 (35.05)
CLFX9900-5/10	20,000 (1378.93)	0.312 (7.92)	5/10							
CLFX9900-10/35	20,000 (1378.93)	0.312 (7.92)	10/35							

Cup-Type Line Filters

CXF4-5	20,000 (1378.93)	0.125 (3.18)	5	SF250CX	0.81 (522.57)	2.94 (74.68)	2.50 (63.50)	0.38 (9.65)	.50 (12.70)	0.81 (20.57)
CXF4-35			35							
CXF4-65			65							
CXF6-5	20,000 (1378.93)	0.218 (5.54)	5	SF375CX	0.81 (522.57)	3.12 (79.25)	2.62 (66.55)	0.47 (11.99)	.62 (15.75)	1.00 (25.40)
CXF6-35			35							
CXF6-65			65							
CXF9-5	20,000 (1378.93)	0.359 (9.12)	5	SF562CX	1.53 (987.09)	4.18 (106.17)	3.50 (88.90)	0.53 (13.46)	.94 (23.88)	1.38 (35.05)
CXF9-35			35							
CXF9-65			65							
CXF16-5	20,000 (1378.93)	0.688 (17.48)	5	SF1000CX	5.00 (3225.80)	6.62 (168.15)	5.75 (146.05)	0.72 (18.29)	1.38 (35.05)	2.12 (53.05)
CXF16-10			10							
CXF16-35			35							
CXF16-65			65							

Note:

** Other micron sizes available on special order. Change last digits of the catalog number accordingly.
For optional materials, see Needle Valve Options section.

*Maximum pressure rating is based on the lowest rating of any component.
Actual working pressure may be determined by tubing pressure rating, if lower.

All dimensions for reference only and subject to change.

For prompt service, Autoclave stocks select products. Consult your local representative.

Dual-Disc Line Filters

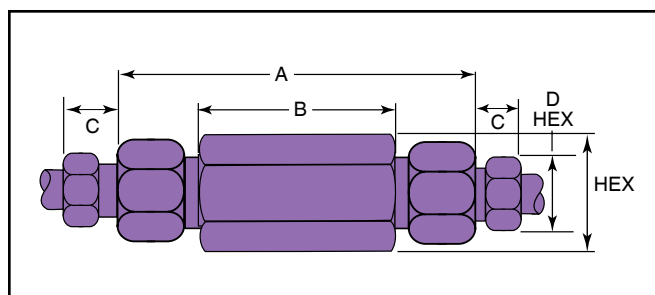

Cup-Type Line Filters

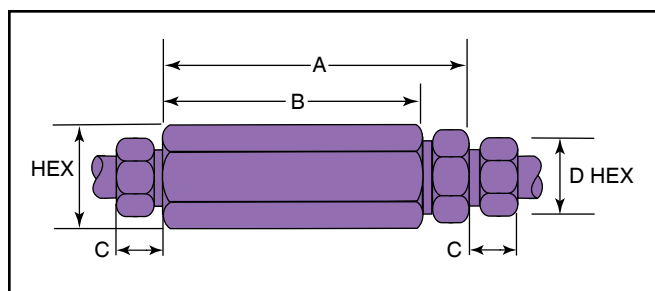

Anti-Vibration Collet Gland Assembly

Pressures to 20,000 psi (1379 bar)

Series KCBGLX Sizes to 1-1/2" (38.10 mm)

For extreme conditions of vibration and/or shock in tubing systems, such as an unsupported line near a compressor, coned-and-threaded connections are offered with the Autoclave anti-vibration collet gland assembly. Completely interchangeable with standard Autoclave Engineers medium pressure connections, the collet gland assembly provides equally effective pressure handling capability.

In standard connection systems, the bending stresses on the threaded area of the tubing imposed by excessive vibration or movement may cause premature fatigue failure of the tubing at the back of the thread. By moving the stress concentration back to the unthreaded part of the tubing and providing a wedge-type gripping action, the Autoclave Engineers anti-vibration collet gland assembly strengthens the entire structure. With stress concentration reduced and overall stress level maintained well below the endurance limit of the material, the result is virtually unlimited vibrational fatigue life.

A less complex and more economical design than other vibration-resistant connections, the collet gland assembly utilizes the same coned-and-threaded features of Autoclave medium pressure connections. Series KCBGLX extends the gland nut to provide room for the tapered slotted collet. The design provides a slight difference in angles between the collet and the corresponding taper of the gland nut. As the nut is tightened, it acts to wedge the tapered end of the collet into a gripping engagement with the tubing.

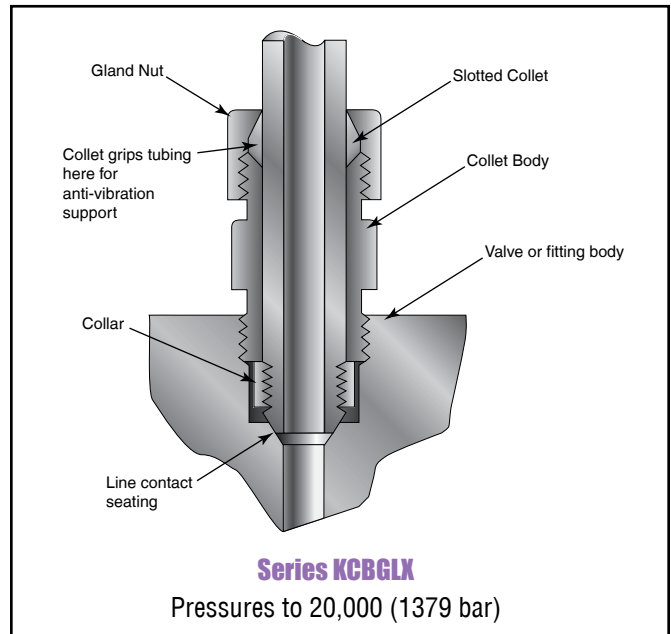

Materials

Type 316 stainless steel with bonded dry film (316 MC) moly lubricant.

- Note: 1) To order components with anti-vibration assemblies add -K to catalog numbers.
2) Special material assemblies may be supplied with four flats in place of standard hex.

Catalog Number	Part	Outside Diameter Tubing Size in. (mm)	Dimensions - inches (mm)		
			A	B	Hex
KCBGLX40-316MC	Complete assembly	1/4 (6.35)	0.94 (23.88)	1.19 (30.23)	0.62 (15.75)
KCBLX40-316MC	Collet body				
KCCLX40-316MC	Slotted collet				
KGLX40-316MC	Gland nut				
KCBGLX60-316MC	Complete assembly	3/8 (9.53)	1.19 (30.23)	1.50 (38.10)	0.81 (20.63)
KCBLX60-316MC	Collet body				
KCCLX60-316MC	Slotted collet				
KGLX60-316MC	Gland nut				
KCBGLX90-316MC	Complete assembly	9/16 (14.29)	1.41 (35.81)	1.78 (45.21)	0.94 (23.88)
KCBLX90-316MC	Collet body				
KCCLX90-316MC	Slotted collet				
KGLX90-316MC	Gland nut				
KCBGLX120-316MC	Complete assembly	3/4 (19.05)	1.59 (40.37)	2.00 (50.80)	1.25 (31.75)
KCBLX120-316MC	Collet body				
KCCLX120-316MC	Slotted collet				
KGLX120-316MC	Gland nut				
KCBGLX160-316MC	Complete assembly	1 (25.40)	1.69 (42.93)	2.38 (60.45)	1.50 (38.10)
KCBLX160-316MC	Collet body				
KCCLX160-316MC	Slotted collet				
KGLX160-316MC	Gland nut				
KCBGLX240-316MC	Complete assembly	1-1/2 (38.10)	2.75 (69.85)	3.63 (92.20)	2.25 (57.15)
KCBLX240-316MC	Collet body				
KCCLX240-316MC	Slotted collet				
KGLX240-316MC	Gland nut				

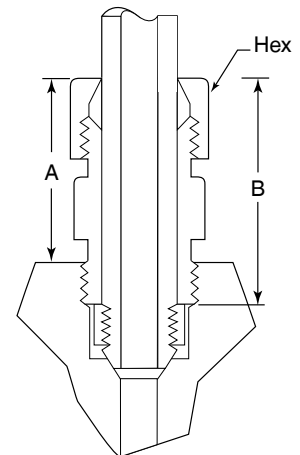

Series KCBGLX
20,000 psi (1379 bar)

Standard Autoclave Engineers collar not included in complete assembly

All dimensions for reference only and subject to change.
For prompt service, Autoclave stocks select products. Consult your local representative.

All general terms and conditions of sale, including limitations of our liability, apply to all products and services sold.

! WARNING !

FAILURE OR IMPROPER SELECTION OR IMPROPER USE OF THE PRODUCTS AND/OR SYSTEMS DESCRIBED HEREIN OR RELATED ITEMS CAN CAUSE DEATH, PERSONAL INJURY AND/OR PROPERTY DAMAGE.

This document and other information from Snap-tite, Inc., its subsidiaries and authorized distributors, provides product and/or system options for further investigation by users having technical expertise. It is important that you analyze all aspects of your application and review the information concerning the product or system in the current product catalog. Due to the variety of operation conditions and applications for these products or systems, the user, through its own analysis and testing, is solely responsible for making the final selection of the products and systems and assuring that all performance, safety and warning requirements of the application are met.

The products described herein, including without limitation, product features, specifications, designs, availability and pricing, are subject to change by Snap-tite, Inc. and its subsidiaries at any time without notice.



Industrial Estate
Whitemill-Wexford
Republic of Ireland
PH: 353 53 914 1566 FAX: 353 53 914 1582
e-mail: ste_sales@snap-tite.com
www.snap-tite.com



Fluid Components
Division of Snap-tite, Inc.
8325 Hessinger Drive
Erie, Pennsylvania 16509-4679 USA
PH: 814-860-5700 FAX: 814-860-5811
e-mail: ae_sales@snap-tite.com
www.autoclave.com

ISO-9001 Certified

02-0124SE-0109